

KW3-401CVB

10.20mm (0.4inch) Orange Red LED Display

Three Digit 7-segment LED Display

Technical Data Sheet

Features

- High reliability
- Low power consumption
- Excellent characters appearance
- Evenly lighted segments
- Wide viewing angle
- Easy mounting on PCB or sockets
- I.C. compatible
- RoHS compliant



Descriptions

- The KW3-401CVB is a 10.20mm (0.4inch) digit height seven-segment LED display.
- The display provides excellent reliability in bright ambient light.
- The device is available as either common anode or common cathode.
- The device is made with white diffused segments and black surface.

Applications

- Home and smart appliances
- Instrument panels
- Display time and digital combination
- Test and measurement equipment
- Control units

Device Selection Guide

Part No.	Emitting Color	Circuit Common
KW3-401CVB	Orange Red	Common Cathode

KW3-401CVB

10.20mm (0.4inch) Orange Red LED Display

Three Digit 7-segment LED Display

Technical Data Sheet

Package Dimension

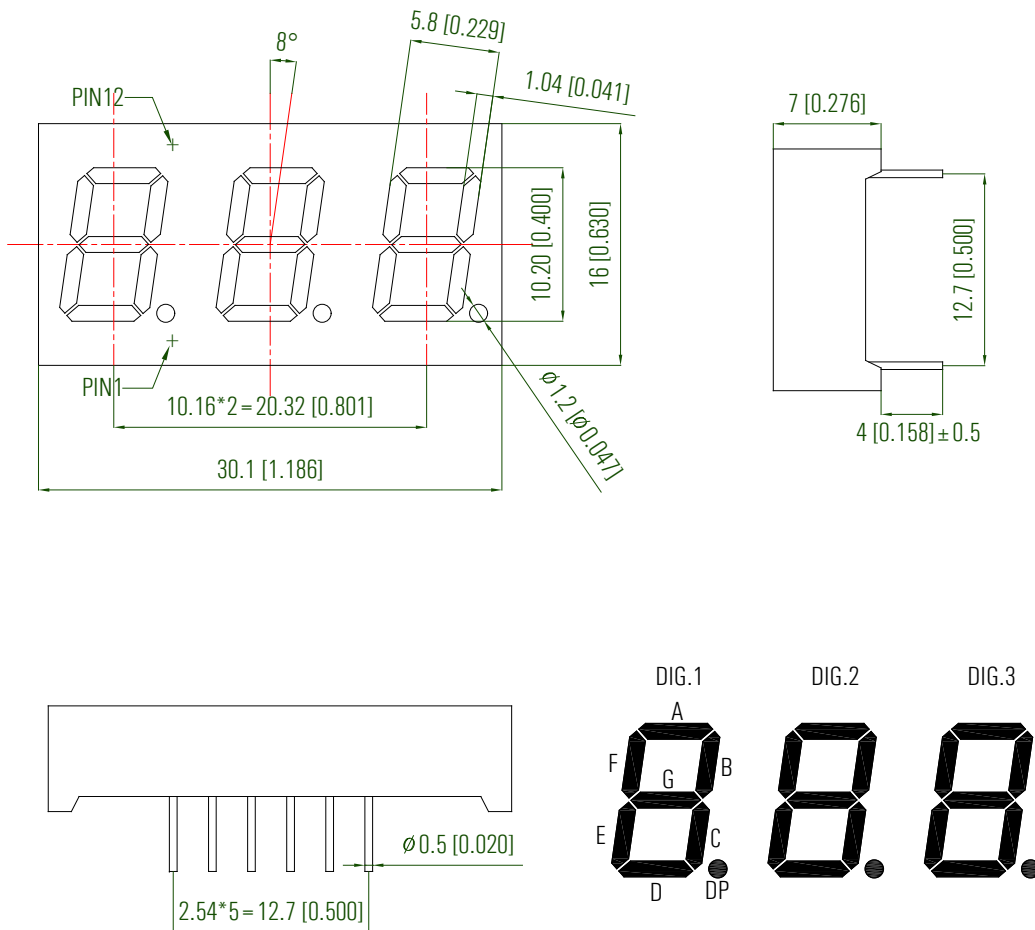

Notes:

1. All dimensions are in millimeters (inches).
2. Tolerance is $\pm 0.25\text{mm}$ (.010") unless otherwise noted.
3. The specifications, characteristics and technical data described in the datasheet are subject to change without prior notice.

KW3-401CVB

10.20mm (0.4inch) Orange Red LED Display

Three Digit 7-segment LED Display

Technical Data Sheet

Internal Circuit Diagram

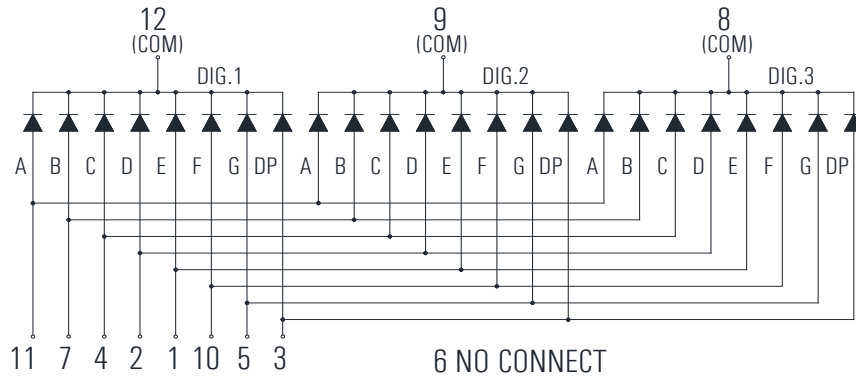

Recommended PCB Layout

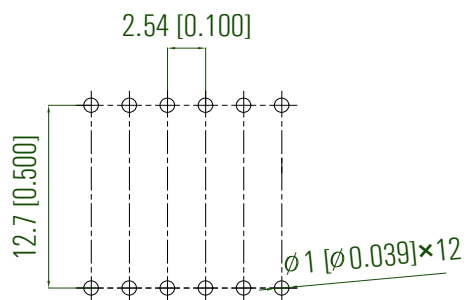

KW3-401CVB

10.20mm (0.4inch) Orange Red LED Display

Three Digit 7-segment LED Display

Technical Data Sheet

Absolute Maximum Ratings at $T_A=25^{\circ}\text{C}$

Parameters	Symbol	Max	Unit
Power Dissipation (Per Chip)	P_D	48	mW
Peak Forward Current (Per Segment) (1/10 Duty Cycle, 0.1ms Pulse Width)	I_{FP}	40	mA
Forward Current (Per Segment)	I_F	20	mA
Reverse Voltage (Per Chip)	V_R	5	V
Operating Temperature Range	T_{opr}	-40°C to +80°C	
Storage Temperature Range	T_{stg}	-40°C to +85°C	
Soldering Temperature	T_{sld}	260°C for 5 Seconds	

Electrical Optical Characteristics at $T_A=25^{\circ}\text{C}$

Parameters	Symbol	Min.	Typ.	Max.	Unit	Test Condition
Average Luminous Intensity	I_v	5.7	11.3	---	mcd	IF=5mA (Note a)
		11.3	22.5	---	mcd	IF=10mA (Note a)
Luminous Intensity Matching Ratio	I_{v-m}	---	---	2:1		IF=20mA
Peak Emission Wavelength	λ_p	---	632	---	nm	IF=20mA
Dominant Wavelength	λ_d	---	624	---	nm	IF=20mA (Note b)
Spectral Line Half-Width	$\Delta\lambda$	---	20	---	nm	IF=20mA
Forward Voltage (Per Segment)	V_F	---	2.0	2.4	V	IF=20mA (Note c)
Reverse Current (Per Segment)	I_R	---	---	50	μA	VR=5V

Notes:

- Luminous intensity is measured with a light sensor and filter combination that approximates the CIE eye-response curve.
Tolerance of Luminous Intensity: $\pm 10\%$.
- The dominant wavelength (λ_d) is derived from the CIE chromaticity diagram and represents the single wavelength which defines the color of the device.
- Tolerance of Forward Voltage: $\pm 0.1\text{V}$.

Typical Electrical/Optical Characteristic Curves at $T_A = 25^\circ\text{C}$

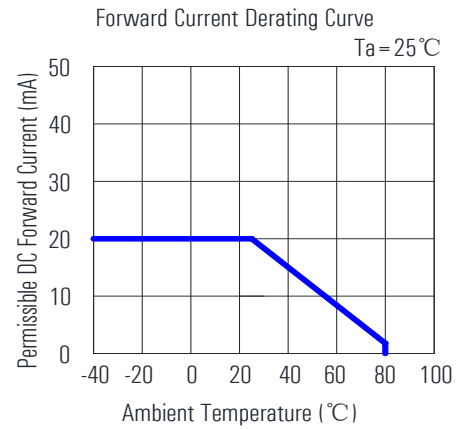
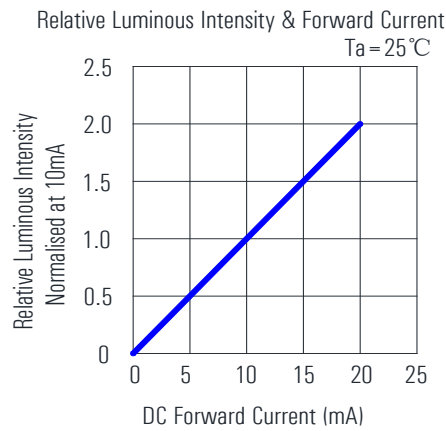
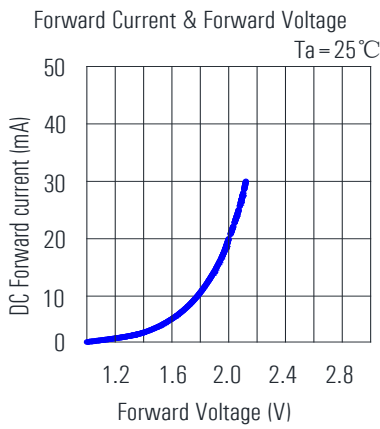
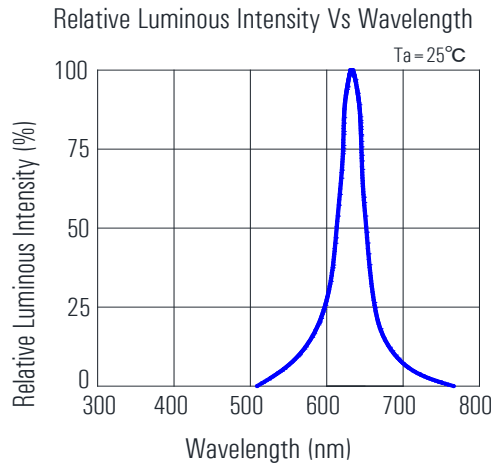

KW3-401CVB

10.20mm (0.4inch) Orange Red LED Display

Three Digit 7-segment LED Display

Technical Data Sheet

Packing & Label Specifications

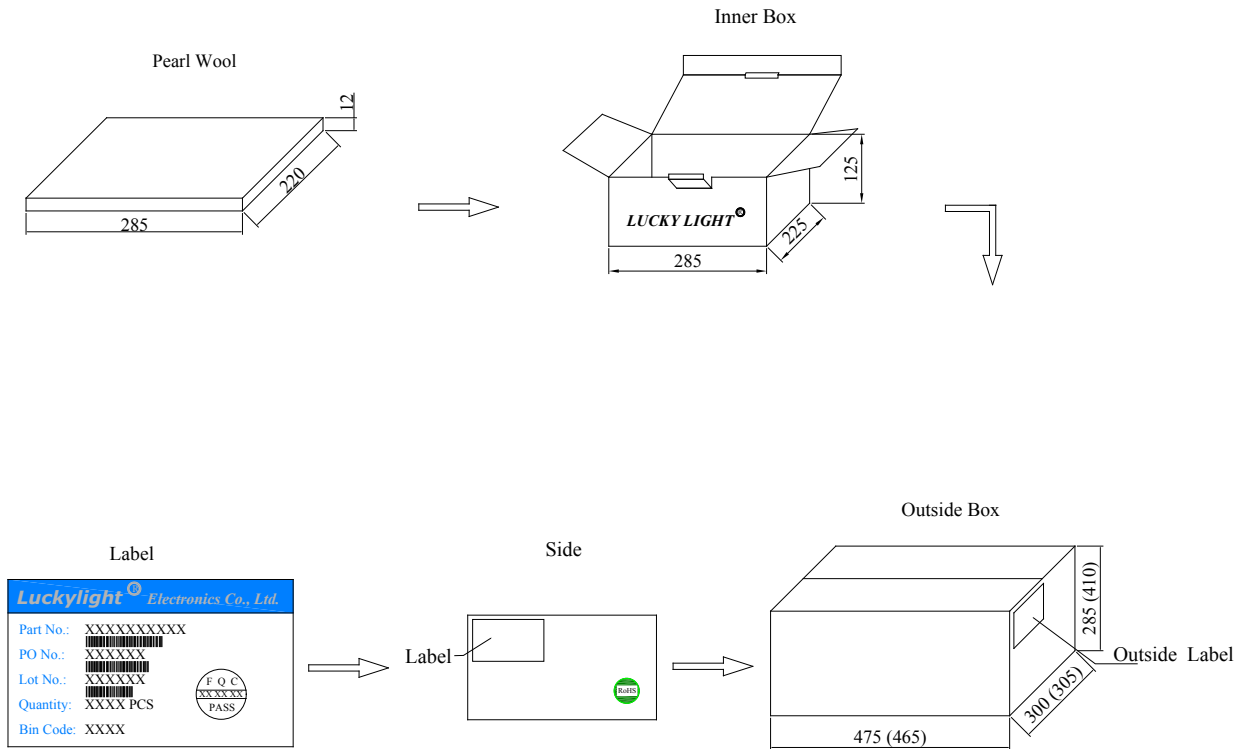

Notes:

1. The above "Packing & Label Specifications" refer to bag packaging and are for reference only.
2. Bag packaging will be used for through-hole LED digital displays with character heights exceeding 0.8 inches.
3. LuckyLight through-hole LED digital displays offer three packaging options: tube, bag, and box. If customers have special packaging requirements, please confirm the required packaging method with the salesperson in advance when placing an order.

Precautions**Through Hole Digital Display Mounting Method****1. Lead Forming**

- 1.1. Do not bend the component leads by hand without proper tools.
- 1.2. The leads should be bent by clinching the upper part of the lead firmly so that the bending force is not exerted on the plastic body.

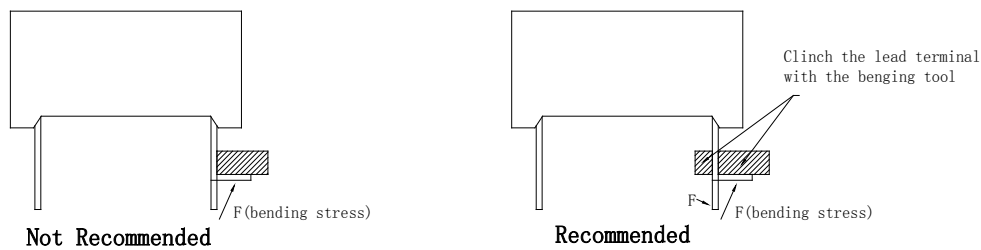
**2. Installation**

- 2.1. The installation process should not apply stress to the lead terminals.
- 2.2. When inserting for assembly, ensure the terminal pitch matches the substrate board's hole pitch to prevent spreading or pinching of the lead terminals.



- 2.3. The component shall be placed at least 5mm from the edge of the PCB to avoid damage caused by excessive heat during wave soldering.

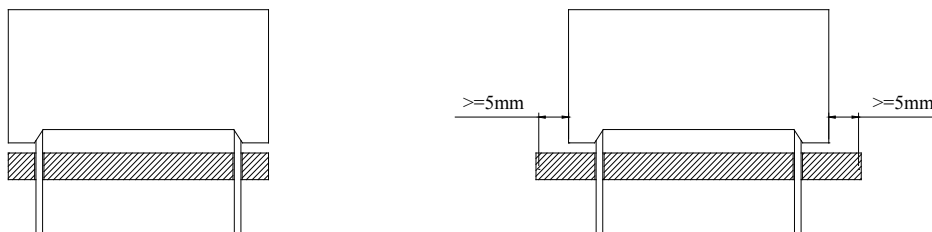

3. Recommended Wave Soldering Profiles

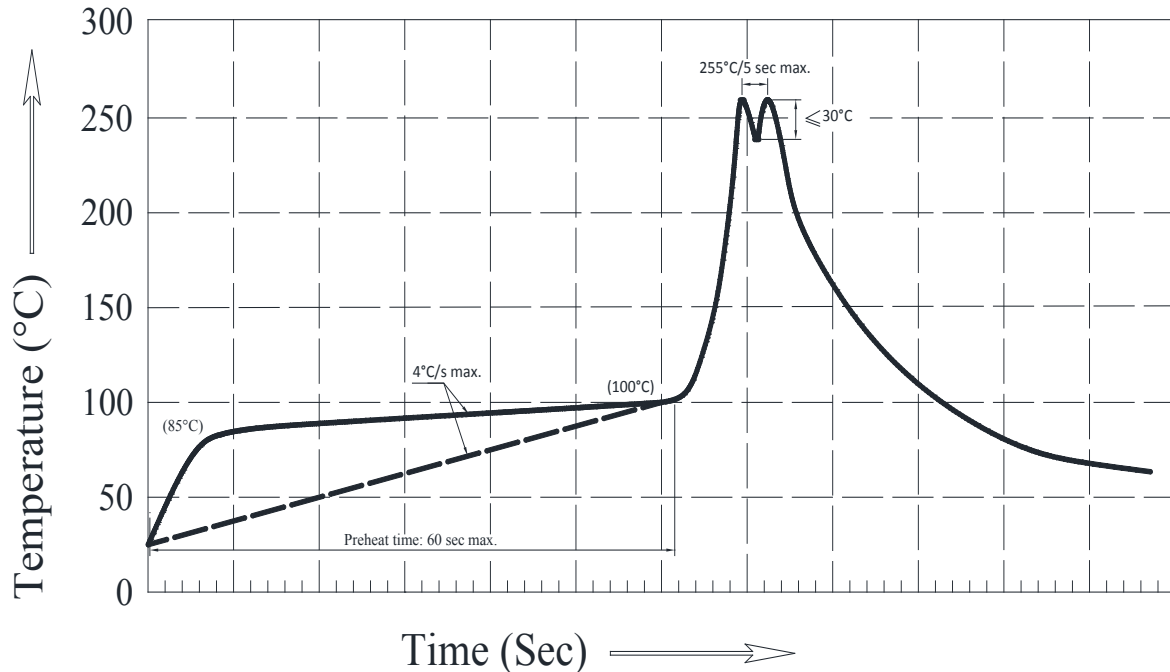

Notes:

- 3.1. It is recommended to pre-heat at a temperature of 105°C or lower (measured using a thermocouple attached to the LED pins) before immersion in the solder wave, with a maximum solder bath temperature of 260°C.
- 3.2. The peak wave soldering temperature should be between 245°C to 255°C for 3 seconds (maximum of 5 seconds).
- 3.3. Avoid applying stress to the epoxy resin when the temperature exceeds 85°C.
- 3.4. Fixtures should not exert stress on the component during mounting and soldering processes.
- 3.5. Only one wave soldering pass is allowed.
- 3.6. Maintain the PCB top-surface temperature below 105°C during wave soldering.

4. Soldering General Notes

- 4.1. Through-hole LED digital displays are not suitable for reflow soldering.
- 4.2. If components will undergo multiple soldering processes or other high-heat treatments, please consult LuckyLight for compatibility.

5. Cleaning

- 5.1. Mild "no-clean" fluxes are recommended for soldering purposes.
- 5.2. If cleaning is necessary, LuckyLight suggests washing components with water only. Avoid using harsh organic solvents for cleaning as they can damage the plastic parts.
- 5.3. The cleaning process should occur at room temperature, and the devices should not be washed for more than one minute.
- 5.4. After using water in the cleaning process, promptly remove excess moisture from the component by utilizing forced-air drying.

6. Circuit Design Notes

- 6.1. Protective current-limiting resistors may be necessary to operate the LEDs within the specified range.
- 6.2. LEDs mounted in parallel should each be placed in series with its own current-limiting resistor.

Recommended Set-up

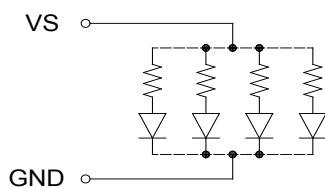

Invalid Set-up

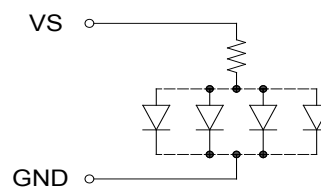

- 6.3. The driving circuit should be designed to protect the LED against reverse voltages and transient voltage spikes when the circuit is powered up or shut down.
- 6.4. The safe operating current should be selected by taking into account the maximum ambient temperature of the operating environment.
- 6.5. Extended reverse bias should be avoided as it may result in metal migration, leading to an escalation in leakage current or potential short circuits.

7. LED Storage Instructions

- 7.1. Store LEDs at or below 30°C and 80% relative humidity (RH) before opening the package.
- 7.2. LEDs should be used within one year of purchase.
- 7.3. After opening the package, store LEDs at or below 30°C and 60% RH.

Disclaimer**1. Product Material and Specification Adjustment Rights:**

LuckyLight reserves the right to update product materials or specifications to improve reliability, functionality, design, or for other valid reasons.

2. Description of Data in Datasheets:

The data presented in this datasheet represents typical values and does not constitute guaranteed figures. The data provided is for reference purposes only.

3. Compliance with Usage Instructions:

When using this product, please strictly adhere to the absolute maximum ratings and instructions outlined in the specification sheets. LuckyLight shall not be held responsible for any damage resulting from non-compliance with these instructions.

4. Application Limitations:

This product is not intended for applications in military, aviation, automotive, medical, life-sustaining, or life-saving fields where failure could cause personal injury or death. For specific application requirements, please consult an authorized LuckyLight sales representative.

5. Disclaimer:

LuckyLight strives for accuracy in its datasheets, specifications, and disclosures. However, we cannot be held liable for any errors or omissions. Product suitability for specific applications is the customer's responsibility.

6. Limitation of Liability:

LuckyLight's liability is limited to the cost of the product. We are not liable for any damages arising from product application, continued production, or any product usage.

KW3-401CVB

10.20mm (0.4inch) Orange Red LED Display

Three Digit 7-segment LED Display

Technical Data Sheet

Revision History

Version	Date	Contents	Page
Version 1	March 16, 2009	Original Version	/
Version 2	December 10, 2012	Update the layout of the specifications data sheet	/
Version 3	June 5, 2017	Optimize product data	4
Version 4	August 17, 2022	Update the company logo, product images, specification drawings, and optical-electric curve charts, Packaging specifications	1-6